

Contents

Presentation _____	98
Description _____	100
➤ The external units _____	100
➤ The indoor station _____	101
Installing of the DoorPhone _____	103
➤ Installation rules _____	103
➤ Installing the external caller unit _____	104
➤ Installing the controller _____	105
➤ Installing the indoor station _____	107
Programming the caller unit with keypad (1) _____	108
➤ Programming and changing personal access code _____	108
➤ Registering and managing badges _____	109
Functional testing _____	112
➤ Testing communication with each indoor station _____	112
➤ Testing access commands using badges (1) _____	112
Appendices _____	113
➤ Radio recognition (2) _____	113
➤ Setting the type and level of ringing _____	113
➤ Connection of an electric lock release or strike _____	114
➤ Connection of a motorised gate _____	114
Quick installation _____	116
What to do if...? _____	118
Technical specifications _____	120

(1) Only for installations fitted with a street side keypad and badge reader.

(2) The products supplied in a kit function together as soon as you insert the batteries.

It is not necessary to carry out radio recognition for these products.

Any handsets purchased as an accessory to a kit or issued as replacements will require radio recognition as described in the appendix.

Presentation

COMPOSITION OF A DOORPHONE

requires as a minimum ① + ② + ③

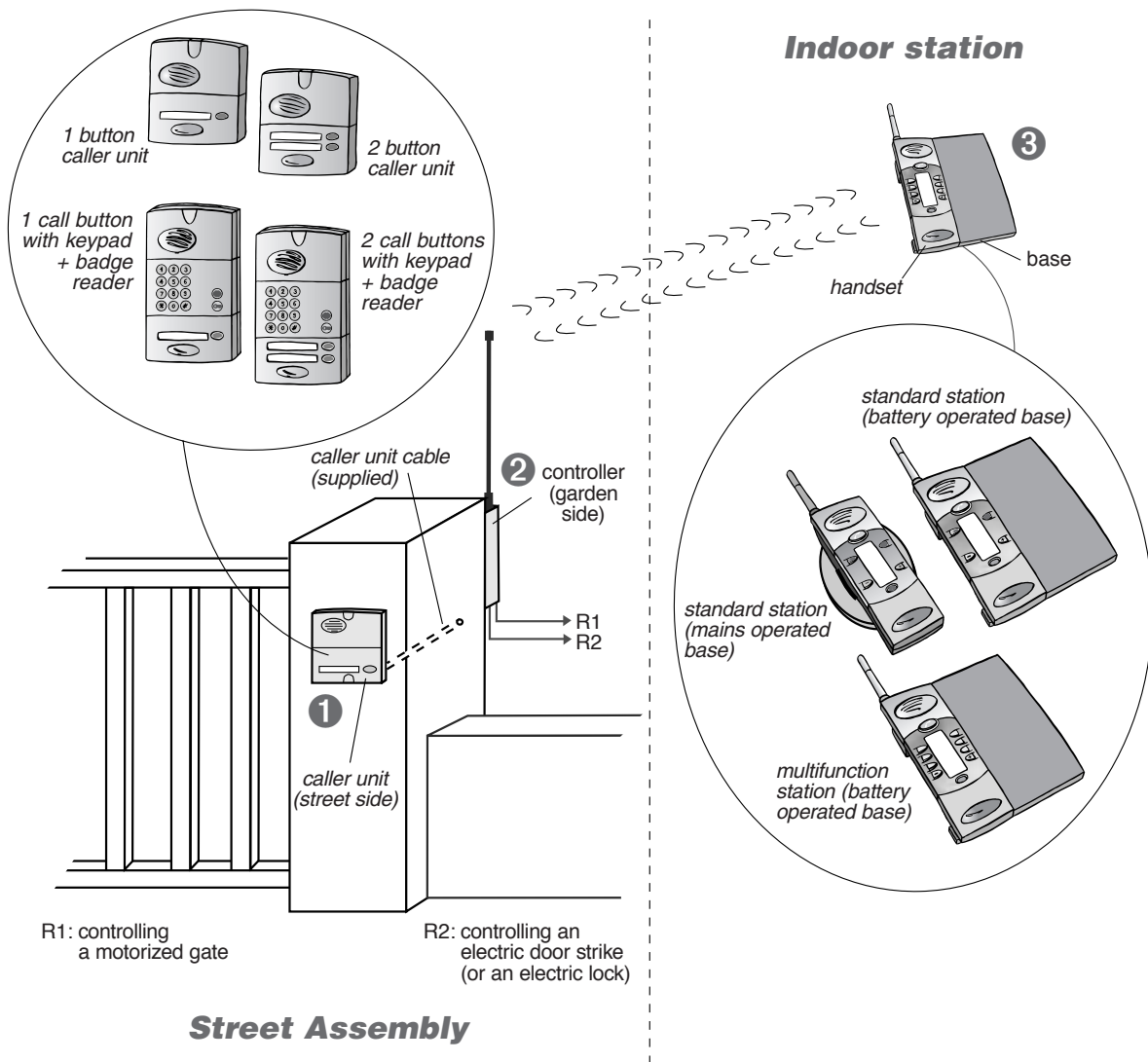

Presentation

• Every kit comprises as a minimum:

- ① A caller unit on the street side for visitors.
- ② A controller installed on the same pillar (garden side), ensuring:
 - the radio link with the indoor station
 - the powering by batteries of the caller unit and controller
 - output connections described in R1 and R2.These products are connected by a cable that passes through (or around) the pillar.
- ③ An indoor station (base and handset) for the reception of calls and the remote control.
There are 2 models of handset:
 - the standard handset (6 keys) allows:
 - the control of a door strikes (or electric lock)
 - the control of a motorised gate
 - the control of lighting (2)
 - the multifunction handset (10 keys) allows:
 - the control of 2 door strikes (or electric locks) (1)
 - the control of 2 motorized gates (1)
 - the control of 2 automatic devices (eg.: motorized garage door...) (2)
 - the control of lighting (2)

(1) requires the installation of 2 caller units and controllers
(2) requires a lighting and automatic device controller

• On the street side keypad, commands can be effected:

- using a personal access code,
- using an auxiliary access code,
- by reading a badge.

• Identifying each user via a badge

The keypad has on its front a badge reading zone enabling each user to control his access more quickly by badge recognition. Placing the badge in front of the name label enables the user to dispense with his personal access code and/or his auxiliary access code before pressing one of the command keys.

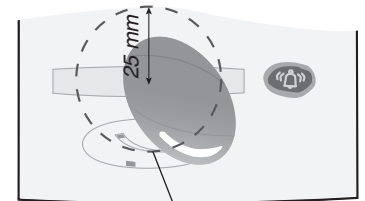

The badge is detected within this zone at a maximum distance of 20 mm

The street side station can handle up to 32 different badges per call button. Each badge must be registered on the street side station.

Description

➤ The external units

• The caller units

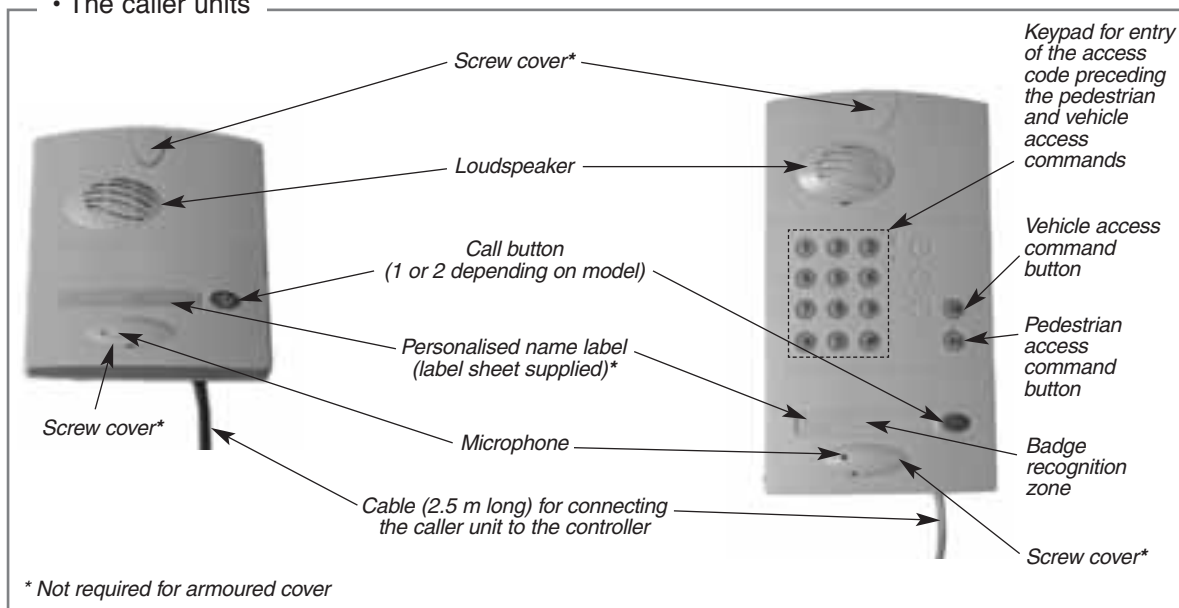

• The controller

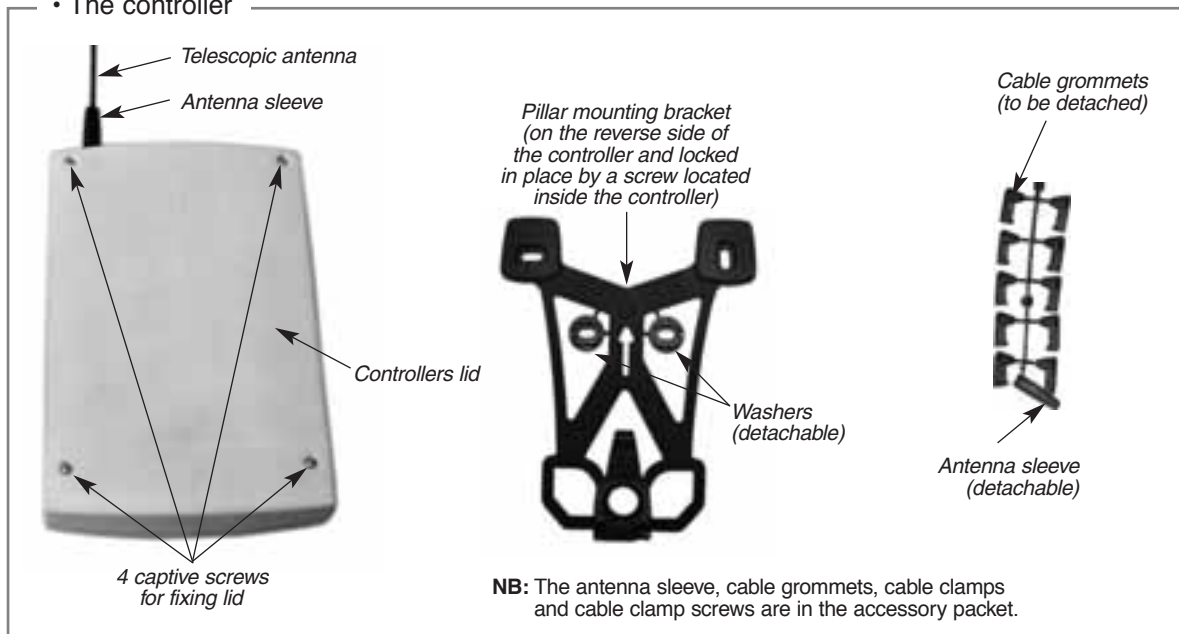

Description

• The controller (continued)

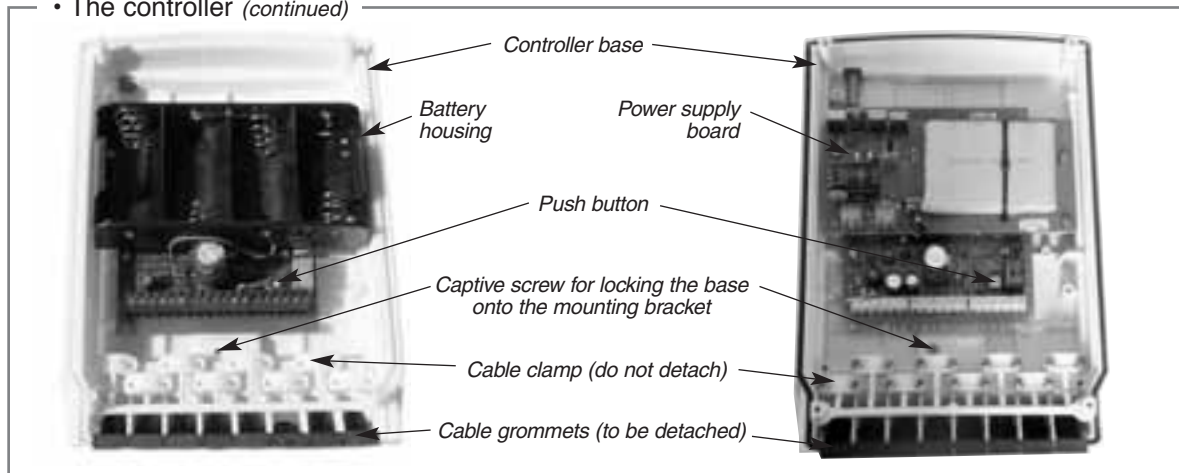

➤ The indoor station (base)

• Battery operated base

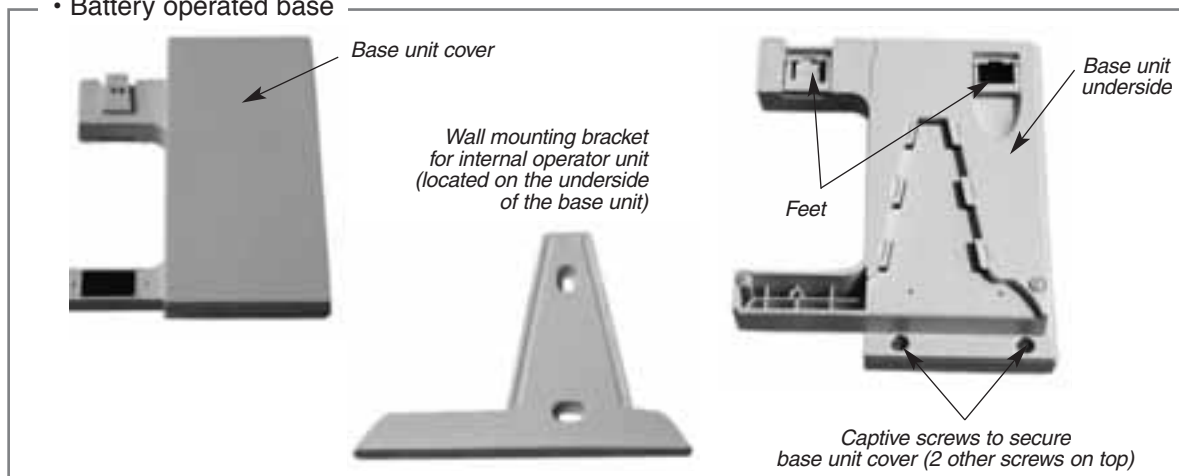

• Mains operated base

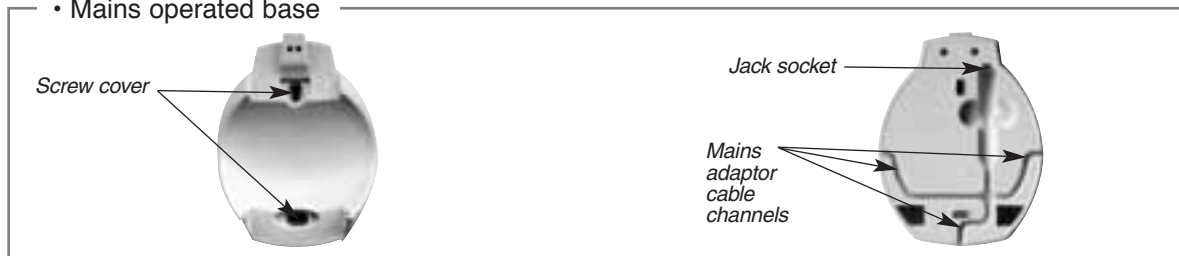

Description

➤ The indoor station (handset)

- The handset (see user guide for more of details on the handsets keys)

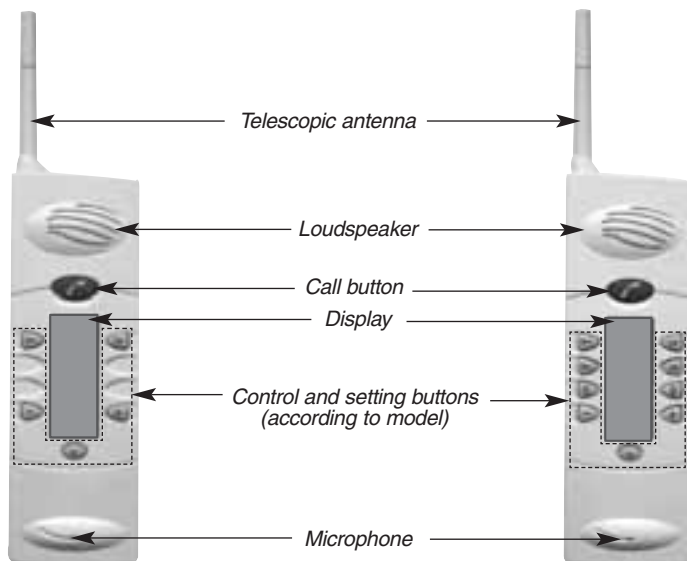

NB: the battery cover is located at the rear of the handset

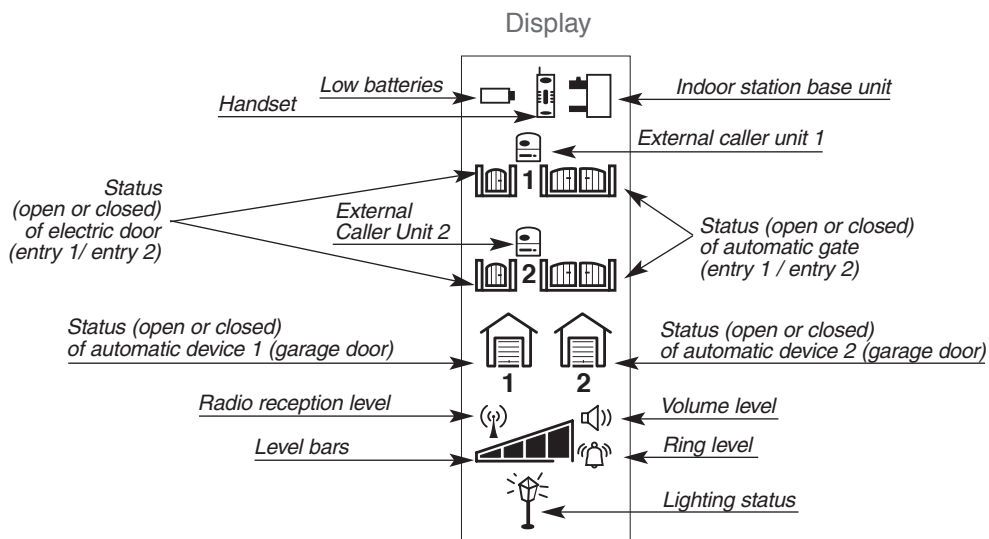

NB: only the indicators specific to your installation will be displayed.

Installing the DoorPhone

➤ Installation rules

In order to ensure its weather-tightness:

- ① The technical controller must always be fitted antenna upwards.
- ② Ensure the antenna is tightened correctly.
- ③ At the time of installing, always use the cable grommets.
- ④ After wiring, ensure the controller's lid is correctly fitted.

In order to ensure good radio range:

- ① Reserve a free space around the technical controller's antenna (to a height of about 80 cm).
Clear all dense vegetation in proximity and ensure it is maintained.
- ② Place the controller as high as possible and ensure the antenna is clear of the mounting surface (example: the antenna must not touch the gate pillars cap).
- ③ Limit the presence of obstacle between the location of the controller and the house where handsets are installed.
- ④ The antenna must be completely extended.

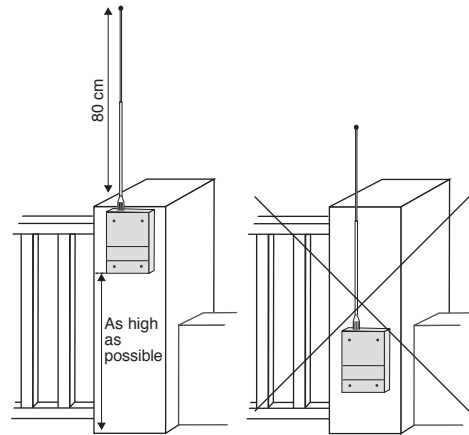

- ⑤ Never run a cable along side of the antenna (notably the cable between the caller unit and the technical controller).
Don't coil the cable close to or in the controller, but cut the surplus.

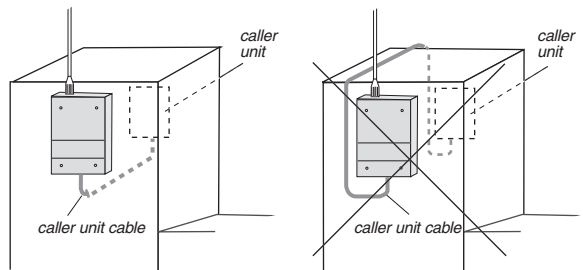

- ⑥ Also avoid placing the products close to metallic items (metal grilles, enclosures, metallic gates...) or sources of electromagnetic disturbance:
 - for the technical controller: electric meter, high tension electric lines, automatic gate controller, lighting controller, radio receiver...
 - for the handset: television, cordless telephone, domestic electric devices, electricity meter or panel, computer, hi-fi, lighting controller....
- ⑦ The technical controller must be at least 2 m from the handset location.

NB: if it is necessary to improve the radio range, see the recommendations in the "What to do if?" section of this guide.

Installing the DoorPhone



Required equipment

- Drill and 6mm dia. Bit
- If the cable goes through the pillar, drill and 8mm dia. bit minimum.
- Philips or pozidrive no2 type screwdriver for mounting screws
- 3.5mm dia. flat screwdriver for terminal block screws
- All mounting screws and plugs are supplied.

➤ Installing the external caller unit

! To preserve water tightness, never attempt to open the external caller unit!

1

For ease of use, we recommend you install the external caller unit approximately 1.20m from the ground.

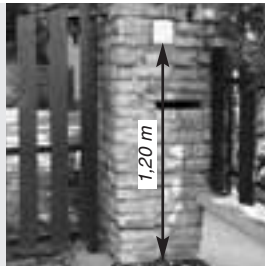

2

Use the drilling template (provided at the end of this manual), mark and pierce with a 6mm dia. drill.



For the installation of armoured caller units, see the mounting instructions provided with the armoured housing.

3

A - If the cable passes through the pillar, use the drilling template to mark the cable hole (8mm dia. drill bit recommended)



A

B - If the cable goes around the pillar, pierce one of the openings located on the sides of the caller unit using a rat-tail file or a cutter for cable entry.



B

4

Push out the 2 screw covers using a flat screwdriver at the back of the external caller unit.



5

Run the cable (according to step 3). Fix the external caller unit (screws and plugs supplied). Re-fit the screw covers.



6

Write the users name with a permanent marker on one of the labels. Stick one of the transparent protective labels over it.

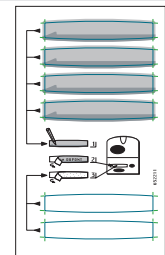

This step is not necessary for armoured housing.

Installing the DoorPhone

➤ Installing the controller

So that it is easier to hook the base on the mounting bracket, choose a flat surface on the garden side pillar (or make it as flat as possible), especially for the top of the part.
If necessary, use a wedge (not supplied)

To remove the fixing bracket, unscrew the locking screw situated inside the controller.

1

Mark the 3 mounting points and drill the pillar with a 6mm dia. drill.

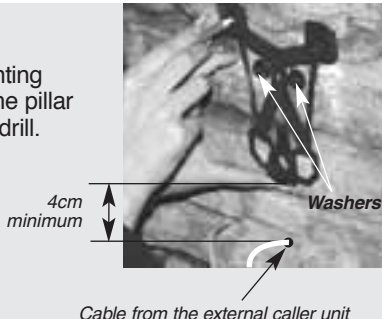

4cm minimum

Washers

Cable from the external caller unit

2

Fix the bottom then the top of the bracket.

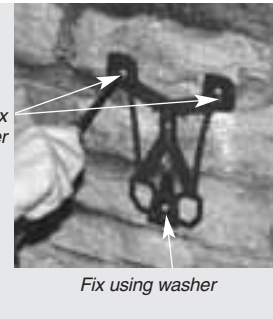

Fix without washer

Fix using washer

! Detach the unused washer

3

Attach the controllers base to the mounting bracket.



4

Fix the base to the bracket with the use of the locking screw.



5

Remove the antenna sleeve and slide it onto the antenna from the top towards the bottom.



Firmly screw the antenna onto the controllers base and lower the antenna sleeve as far as possible.

6

Detach a cable grommet and pierce it just to the diameter of cable using a crosshead screwdriver in order to allow the passage of the cable of the caller unit.



Installing the DoorPhone

7

Cut the cable to the required length. Pass the cable through the cable grommet. Strip the ends of the wires.



 **The cable must be completely uncoiled.**

8

Connect the 6 wires from the external caller unit to terminals 7 to 12.*

7 (yellow)
8 (brown)
9 (grey)
10 (green)

7 & 8: Data bus
9: Loudspeaker
10: Microphone
11: +6V
12: 0V

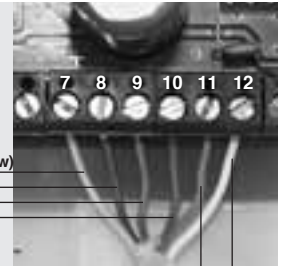

11 (pink)
12 (white)

9

Slot the grommets into their slots and position them to ensure the weather resistance of the controller. Be sure to also fit any un-pierced grommets. It is imperative to fit all cable grommets.



 **Ensure correct orientation of the grommets.**

10

Use the screws provided to hold the connected cable(s) by tightening the cable clamps.



 **Do not remove the cable clamps from their holder.**

11

Insert the four 1.5 V LR20 batteries supplied. Press the push button to initialise the controller.



 **Push the batteries into the holder ensuring good contact between the + pole of the battery and the metal clip.**

OR

For mains powered units supply:
Terminal block R1: supply for the EXTPOWER PCB (input voltage from 8 V to 24 V AC / 12 V to 30 V DC).
Terminal block R2: supply to the technical controller (output voltage 6V DC).

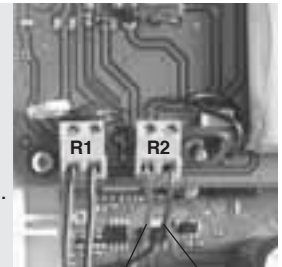

red black

12

Insert the cover onto the base and secure it with the 4 screws.



13

Fully extend the telescopic antenna in order to get optimal radio range.

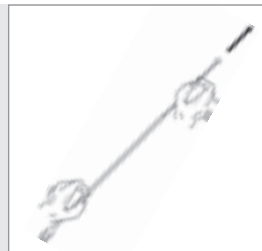

* If connecting a strike or electric 12V lock, the position contact input of the motorised gate must be connected. Refer to the Connections chapter in the appendices.

Installing the DoorPhone

➤ Installing the indoor station (battery operated base)

The indoor station must be placed more than 2m away from the controller!

1

For ease of use it is recommended the indoor station be mounted approximately 1.5m from the floor.

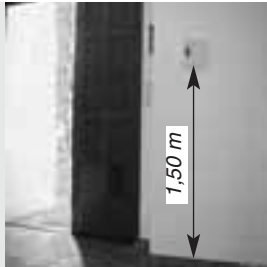

2

Mark the two wall bracket mounting holes with a 6mm dia. drill.



3

Open the base unit by unscrewing the 4 screws located on the underside. Insert the four LR20 batteries and relocate the lid using the 4 captive screws.



4

Fit the base to the mounting bracket.



5

Open the battery access flap.



Connect the battery.





Place the handset on its cradle. It will emit 3 beeps.



The  indicator displays to show the handset is being charged.

6

Test the radio reception. At a distance of more than 3m away from the controller, press the  button. Watch the radio reception indicator . If more than 2 bars are displayed the level is good. (1) When the test is done press .(2)



(1) It is recommended to do this test while moving into other rooms and going outside, to check the radio reception. If the level of reception is insufficient please look in the "What to do if...?" section of this guide.

(2) 3 minutes after pressing the , key, the handset emits a resonant BEEP and the  indicator disappears.

GB

Installing the DoorPhone

➤ Installing the indoor station (mains operated base)

The indoor station must be placed more than 2m away from the controller!

1

For ease of use it is recommended the indoor station be mounted approximately 1.5m from the floor.

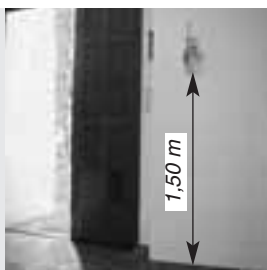

2

Mark the two base mounting holes with a 6mm dia. drill.

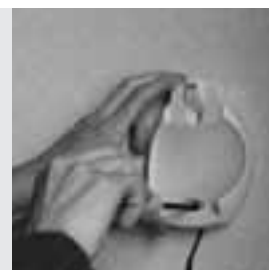

3

Plug in the power jack. Route the cable through its channel. Screw the base to the wall. Plug in the mains transformer. Re-fit the bases screw covers.

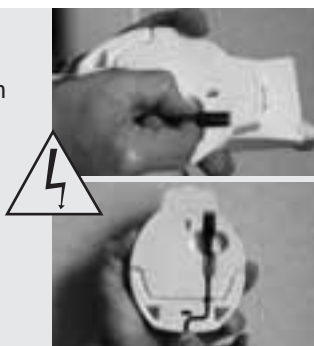



4

Having screwed the base to the wall, place the handset in its cradle and it will beep three times.

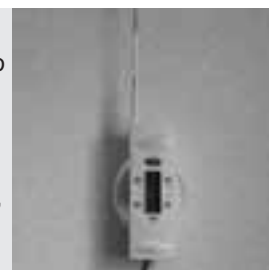

The  indicator appears, showing the handset is being charged.



5

Test the radio reception. At a distance of more than 3m away from the controller, press the  button. Watch the radio reception indicator . If more than 2 bars are displayed the level is good. (1) When the test is done press .(2)



- (1) It is recommended to do this test while moving into other rooms and going outside, to check the radio reception. If the level of reception is insufficient please look in the "What to do if...?" section of this guide.
- (2) 3 minutes after pressing the  key, the handset emits a resonant BEEP and the  indicator disappears.

Programming the caller unit with keypad

➤ Programming and changing a personal access code

A 4 or 6 digit access code must be programmed to facilitate the control of the lock and gate release.

*Personal
access
code*

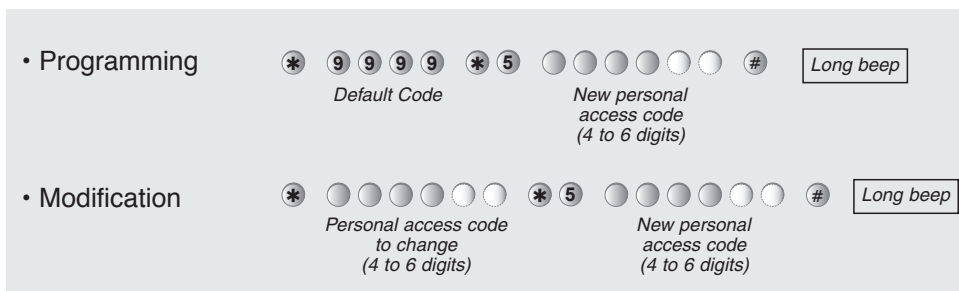

Please note: during programming, all programming errors (erroneous access code, incorrect number press, too brief press...), are signalled by three short BEEPs or by one warning BEEP!

What to do in case the personal access code is lost or after replace the external caller unit?

Remove the controllers cover and press the small button inside.

You have 20 seconds in which to do the programming of the personal access code using the 9999 code as explained above.



Programs linked to the auxiliary code remain unchanged.



GB

Programming the caller unit with keypad

➤ Registering and managing badges

It is possible to register up to 32 badges per call button. Each call button is managed individually for registering and erasing badges.

• Registering badges

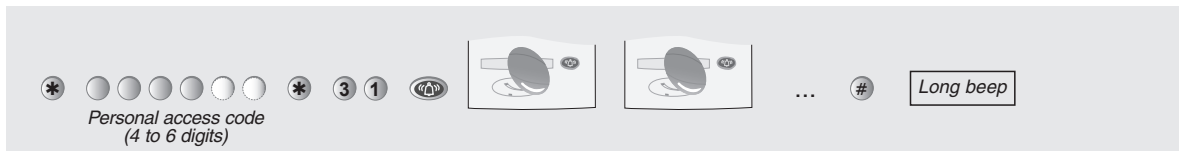

Note: if more than 10 s elapse between the introduction of 2 badges, the station sounds 3 error beeps when the badge is introduced. If this happens, restart programming from the beginning for non registered badges.

• Erasing badges

Programming required if one or more badges are lost or need to be erased.



Note: erasing a badge causes all badges registered on the key to be erased. Consequently, all the badges attached to that key must be reregistered.

Programming the caller unit with keypad

• Programming options

The programming options below refer only to installations fitted with both a release command and a motorized gate command. These programming options are associated solely with the use of badges.

- Pedestrian access priority:

* ● ● ● ● ● ● * 3 2 1 # Long beep

*Personal access code
(4 to 6 digits)*

Pedestrian access is controlled as soon as the badge is presented in front of the station.

- Car access priority:

* ● ● ● ● ● ● * 3 2 2 # Long beep

*Personal access code
(4 to 6 digits)*

Car access is controlled as soon as the badge is presented in front of the station.

- Erasing of access priorities (reset to factory settings)

* ● ● ● ● ● ● * 3 2 0 # Long beep

*Personal access code
(4 to 6 digits)*

GB

Functional testing

➤ Testing communication with each indoor station

1

Press the call button .

To confirm the call, the caller unit emits a 'DING DONG' at regular intervals for 30 sec.





2

The handset sounds ("DING DONG" at regular gaps for 30 seconds or as long as communication with the caller unit remains un-established) and the  indicator blinks on the display.



3

Pick up the handset and press the  key.

The  and  indicators flash alternately to signal that communication is under way. Verify communication with the caller unit.



4

To end the communication, press , (the handset gives out a resonant BEEP to indicate disconnection) or hang up the handset on its base, the  indicator becomes steady again.

➤ Testing access commands using badges

• Controlling pedestrian access:



then .

Check that the lock unlocks.

Note: when only an electric lock is connected, pedestrian access is controlled as soon as the badge is presented in front of the station. There is no need to press the  key.

• Controlling car access:



then .

Check that the gate motorization works.

Note: when only a door motorization is connected, car access is controlled as soon as the badge is presented in front of the station. There is no need to press the  key.

Appendix

➤ Radio recognition

 **It is necessary for all handsets added to a kit or replacement handsets to undergo radio recognition!**

- Carry out the radio recognition using:
 - each of the handsets if the installation has several,
 - each of the buttons of the external caller unit if it has 2 call buttons,
 - each of the external caller units if the installation has two.
- Radio recognition enables each handset to identify the external caller unit(s) connected to it. Carry out the following procedure.

1

Open the controllers cover and press the small pushbutton.

 **You have 20 s to carry out step 2.**





2

On the other side of the pillar press the call button  on the caller unit. It will start to beep.

 **You have 20 s to carry out step 3.**



3

During the BEEPING, press and hold the handsets  and  keys simultaneously, that correspond to the caller unit until the handset emits a resonant BEEP and shows the  symbol (the procedure is identical for the 6 button handset).



NB: if there has been neither a beep nor a display, radio recognition has failed. Start the procedure again from the beginning ensuring you leave at least 3 seconds between pressing the button on the controller and the button on the external caller unit, and that you keep the handset at least 2m from the controller.



➤ Setting the type and level of ringing

1

To change the ring type (3 ring types available), press the handsets  key for 5 secs.



2

To adjust the ring volume, press the handsets  or  keys.

The display indicates the level set .





NB: it is also possible to adjust the speech volume level during communication (see. User guide).



Appendix

Before making any connections disconnect one of the 4 batteries in the controller to avoid any risk of short circuit!

➤ Connection of an electric lock release or strike

- 1 Pass the cables through cable entry grommets (see. diagram of the controller)
- 2 Make connections as indicated on the diagram on the next page.
Cable gauges required:
 - terminals 1 and 2: 0,75 mm² up to 15m/1,5 mm² up to 30m
 - terminals 3, 4, 5 and 6: 0,22 mm² (telephone type cable)
- 3 Reconnect the battery and press the “BP” button in the controller.
After 20 seconds, the handsets display indicates the relative information.
The electric lock control is ready-for-operation (See. User guide).
NB: if a position contact is connected, its change of state will be displayed on the handset after a maximum of 5 seconds.
- 4 Fit the used grommets in their slots on the controllers base.
NB: in factory default, the door control output is adjusted to last 2 secs. It is possible to adjust the duration to 5 secs to suit your application:
 - Press the entrance 1/entrance 2 key  for more than 5 seconds, the handset emits a resonant BEEP and the  indicator blinks,
 - press the  key to change to 5 secs, the handset emits 2 resonant Beeps.To revert to 2 secs, use the same procedure but press  instead of .

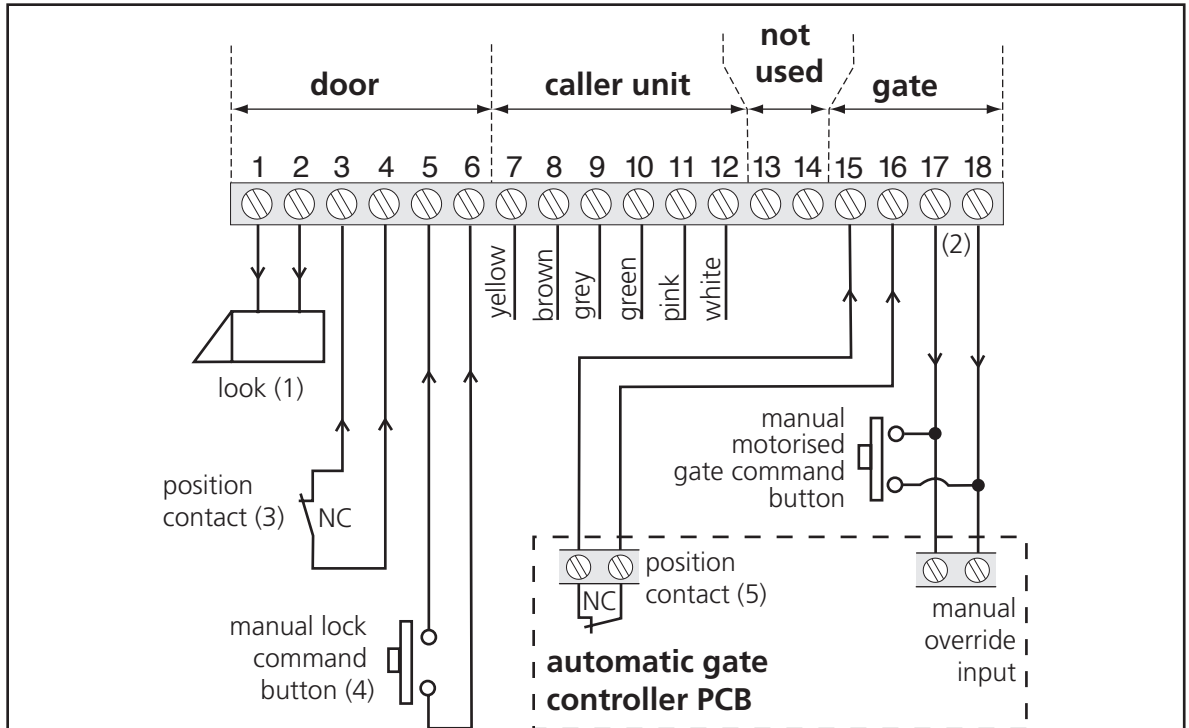

➤ Connection of a motorised gate

- 1 Pass the cables through cable entry grommets (see. diagram of the controller)
- 2 Make connections as indicated in the diagram on next page.
The gauge of cable required is: 0.22 mm² (telephone type cable)
- 3 Reconnect the battery and activate the gate controller with its usual command (not via the handset).
After about twenty seconds, the handsets display indicates information related to the motorized gate. The motorized gate is ready-for-operation (see. User guide).
NB: if a position contact is connected, its change of state will be displayed on the handset after a maximum of 5 seconds.
- 4 Fit the used grommets in their slots on the controllers base.





(1) Command of electric lock or strike. 12 V/1.5 A max.
No external power needed.

(2) Command of a motorized gate, output relay: dry contact 48 Vcc/1 A
If a push button for manual control of the automatic device is already installed, connect terminals 17 and 18 in parallel to this input of the gate controller.
The gate control equipment requires external power.

(3) Connection is not obligatory; link out the 2 terminals if not used.
Allows for the state of the door to be displayed on the handsets LCD screen:
-  door closed (contact closed)
-  door open (contact open)

(4) Connection not obligatory
Push button placed inside the door allowing manual egress control.
Place this control out of reach and view from the street if fitted to pedestrian gate.

(5) Connection not obligatory; link out the two terminals if not used
Allows for the state of the gate to be displayed on the handsets LCD screen:
-  gate closed (contact closed)
-  gate open (contact open)

Quick installation

• External caller unit installation*

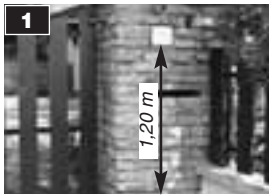

• Controller installation

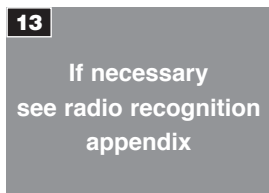
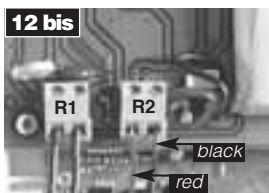
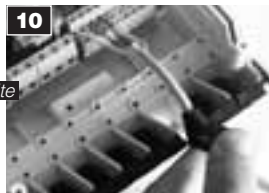
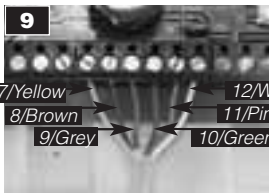
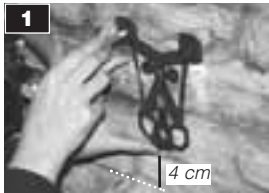

Quick installation

• Battery operated indoor station installation

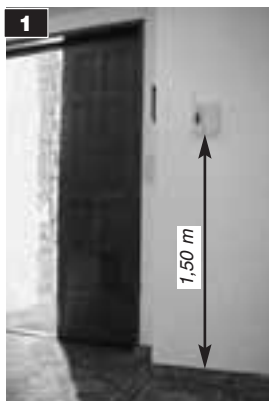



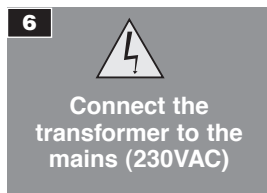
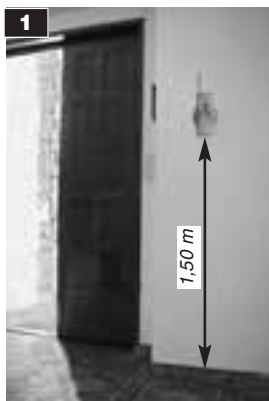







Mains operated indoor station installation



* for metal caller units, see the guide provided with the metal cover.

What to do if...?

Problem	Solution
What does a short noise in the handset mean?	This can occur when interference is detected; it means the channel has changed (Dynapass® Technology)
What does a continual noise in the handset mean?	This can occur at the edge of radio reception. When beyond the limit, the call is cut off.
Reception quality varies greatly when I move with the handset.	<p>Without electromagnetic disturbance and without any obstacles between the handset and the controller, the “free range” radio distance is approximately 400m. When the handset is inside the dwelling, radio transmission range is shorter. In fact, radio wave propagation is affected by the type and thickness of the walls it passes through.</p> <div style="display: flex; justify-content: space-around; align-items: flex-start;"> <div style="text-align: center;">  <p>Trees or bushes reduction of 10% to 30%</p> </div> <div style="text-align: center;">  <p>Plasterboard and wood reduction of 10% to 30%</p> </div> <div style="text-align: center;">  <p>Brick reduction of 30% to 50%</p> </div> <div style="text-align: center;">  <p>Concrete and breeze blocks reduction of 50% to 70%</p> </div> <div style="text-align: center;">  <p>Metal and metallic cladding reduction of 70% to 90%</p> </div> </div>
I want to work on the controllers connections after several weeks of DoorPhone use (for example, to connect a door release)	Disconnect a controller battery, carry out the connection, reconnect the battery then press the controllers push button. After about 20 seconds the handset displays the new configuration.
When it is returned to its base unit the handset does not beep or display  .	<ul style="list-style-type: none"> ▶ Battery operated base: check the state of the batteries in the base (push the batteries into their holder ensuring good contact between the + pole of each battery and the metallic contact). ▶ Mains operated base: check the mains is present.
During communication testing, the  and  indicators do not blink. The call is not going through to the external caller unit.	<ul style="list-style-type: none"> ▶ If the  indicator is not displayed, carry out radio recognition procedure (see appendix) ▶ If the  indicator is displayed, there is either a problem of radio reception or it may be resolved by pushing the batteries into their housing ensuring a good connection between the + pole and the metallic contact.
The connected automatic gate is not displayed on the handset.	<p>If there is no position contact, check that terminals 15 and 16 on the controller are correctly linked out.</p> <p>If there is a position contact, place the gate in a position so that the contact is closed.</p>
The low battery indicator doesn't disappear when the handset is in place.	The state of the battery is tested every 10 hours and during every communication.
On presenting a badge, the station emits 3 error beeps.	The badge is not registered.

What to do if...?

Problem	Solution
Radio reception is not satisfactory	<ul style="list-style-type: none"> ▶ Check that vegetation doesn't obscure the antenna of the technical controller, if necessary clear it and spread it out. ▶ Try unfolding the handsets antenna to see if an improvement occurs. ▶ Connect a 2.5 m length of telephone type cable to terminal 6 of the controller. Link the other end of the cable to a chain link fence (if there is one) or unwind it and let it run along the ground (Fig. 1) ▶ If the handset operates better in another location relocate it. ▶ Move the controller in order to position its antenna directly in line of sight with the handsets antenna. (Fig. 2 and 3). ▶ Comment: the connection of a strike or electric lock release can increase the radio range appreciably (Fig. 4).

* Controller/caller unit connection

Cut the cable at 1m, extend the pink and white wires according to the indications given below:

- 0.75mm² min up to 8 metres,
- 1.5mm² min up to 15 metres,
- 2.5mm² min up to 30 metres.

Extend the other wires with a telephone type cable and make the connections in a junction box.

Controller/door release connection

Use a cable and use the following gauges:

- 0.75mm² min up to 15 metres,
- 1.5mm² min up to 30 metres.

Controller/automatic gate connections

Use a telephone type cable (0.22mm²)

Controller/position contact connections

Use a telephone type cable (0.22mm²)

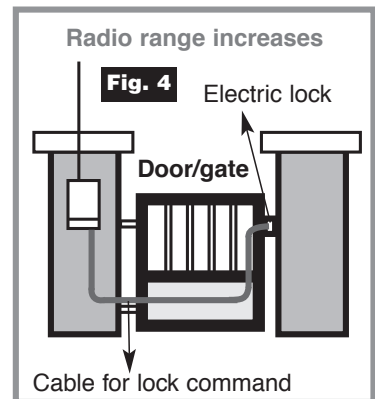
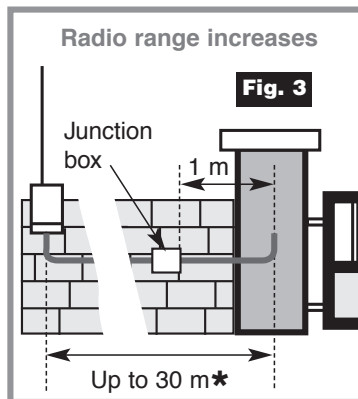
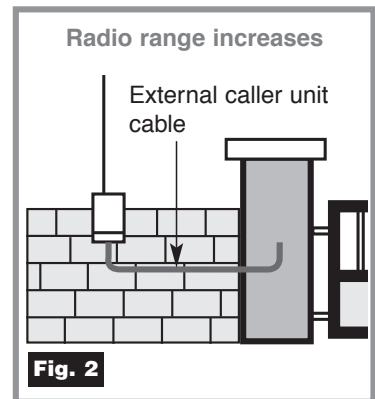
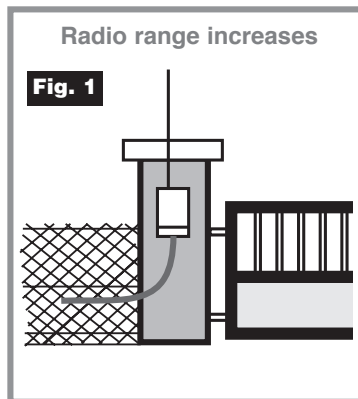

Technical specifications

General features

- **Dynapass**[®] Technology multifrequency ultra-reliable radio, up to 400 m range in free field (1), (will vary according to environmental conditions and installation) (2)
- Radio range up to 400 m in free field (will vary according to environmental conditions and installation)
- High fidelity audio

Controller/Caller unit features

Feature of the street whole

- Polycarbonate housings
- Ingress protection rating IP54: shielded from dust and harmful deposits and streams of water in all directions
- Operating temperature of -20 °C to +70 °C
- Supply of the controller:
 - batteries: 4 alkaline 1.5 V type LR20 batteries
 - mains: power supply card with an input voltage of between 8 V and 24 V AC/12 V and 30 DC and a output voltage of 6 V
- Autonomy 4 years
- Cabled with 6 wires between the external caller unit and the controller
- Control and supply for all types of 12V standard or low current door releases (1,5A maximum)
- VLV automatic control taking a dry contact control 48Vcc / 1 A (relay or switch)
- All inputs/outputs of the controller are standard VLVS type

Feature of the indoor station

- ABS housings.
- Ingress protection rated IP41: protection against solid bodies > 1 mm and from drops of water and condensation in a vertical plane.
- Operating temperature of the interior products of 0 °C to +50 °C
- Voltage supply of the base:
 - batteries: 4 x 1.5V LR20 alkaline batteries (autonomy 4 years),
 - mains: via the 230V / 12V transformer.
- Supply of the rechargeable handset:
 - for battery operated base: battery Lithium-ion (Li-ion)
 - for mains operated base: 3 x AAA NiCad batteries.
- Autonomy of the rechargeable handset:
 - for battery operated base: 4 days,
 - for mains operated base: 2 days.
- The indoor station can operate hands free or in private conversation with the handset picked up
- Adjustable ring volume and ring types and adjustable audio level

(1) The free field range corresponds to the theoretical maximum distance separating the controller and the handset, in the absence of all obstacles (e.g: walls, metal fencing, vegetation, electromagnetic disruption) which by nature would reduce the reach.

(2) To optimise the performance of the DoorPhone, adhere to the installation guidelines contained within and carry out a pre-test.